

## VOVO STYLEMENT

# User Manual

- TCB-080
- TCB-080SL
- TCB-080SA

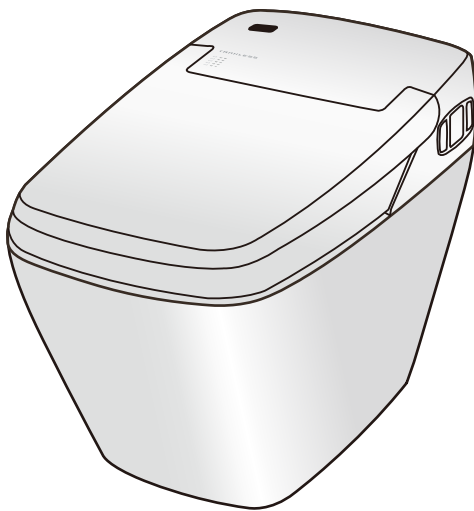

● Please read this manual carefully for proper use.

This manual includes Warranty. Keep the Warranty for customer service.

## Table of Contents





Cautions for Safety .....	3
Cautions in Use .....	6
Proper Usage .....	7
Functions .....	8
Names of Parts .....	9
Preparation and Check Before Use .....	11
How to Use .....	13
Adjusting Temperature .....	14
Adjusting and Using Functions .....	15
Flushing .....	16
Open and Close the Toilet Seat and Lid ..	17
Maintenance .....	18
Ordinary Maintenance .....	18
Other Maintenance .....	20
Troubleshooting .....	22
Customer Support .....	27
Specifications .....	28
Warranty .....	29

# Cautions for Safety

Read all instructions before installation and use.

※ **CAUTION** : In order to avoid a hazard due to inadvertent resetting of the thermal cutout, this appliance must not be supplied through an external switching device, such as a timer, or connected to a circuit that is regularly switched on and off by the utility.

※ The following terms are used in this manual to indicate hazards of varying degrees of severity.

 <b>Danger</b>	Indicates an imminently hazardous situation which, if not avoided, will result in death or serious injury.
 <b>Warning</b>	Indicates dangerous situations where the user could suffer death or serious injury if this product is used incorrectly.
 <b>Do not dismantle</b>	Indicates not to dismantle this product.
 <b>Observe strictly</b>	Indicates to observe the following precaution before using this product.

 **Danger**

 **Do not dismantle** Do not open the product to repair or remodel.  
- Only qualified service person should service this product.

 **Observe strictly**

1. This is an electric appliance. Do not install the product in a place where the product is exposed to splash of water or humidity such as dew formation.  
When installing the product in the bathroom with bathtub, install ventilator to facilitate ventilation.
2. Install outlet far away from bathtub.
3. Connect the power plug to the outlet tightly
4. This product is equipped with a cord having a grounding wire inside the plug must be plugged into an outlet that is properly installed and grounded.
5. When using the product in the bathroom with bathtub and toilet, seal the junction where the power plug and outlet are connected with silicon completely in order to protect it from water or moisture.  
※ In case the junction is not waterproofed, contact the installer.

 **Do not spray water** Do not splash water or detergent on the main body or power plug.



## Do not touch the power cord with wet hands

Do not use broken product.

- In one of the following cases, unplug the power cable, close the shutoff valve.

### Troubles

- Water is leaking from the main body or piping
- The product is broken or cracked.
- There is strange sound or smell
- The smoke is coming out of the product.
- The product is overly heated.

- If you continue to use the product when one of the aforesaid troubles is found, it can cause electric shock or flooding inside the bathroom.



Prohibited

Do not use loose or unstable outlet

- It can cause fire or electric shock.
- Do not exceed the rated voltage of the outlet or the distributor.
- Connecting too many plugs will exceed the rated power and can cause fire by overheat.

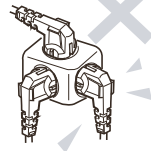

Handle power cord carefully and do not break the cord.

- Do not fabricate or assemble at user's own discretion.
- Do not bend, twist, or pull it forcibly.
- Do not place heavy objects on the cord.

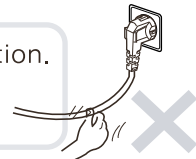

Use of damaged cord can cause fire, electric shock, or short circuit.

One of the following persons needs to have someone to turn off the temperature controller of the seat and warm air blower when using heated seat.



Observe strictly

- Children or elderly persons who cannot control the temperature appropriately by themselves.
- Patients or sick persons who cannot move her or his body by oneself.
- Persons on medication that make them drowsy, and fatigued and intoxicated persons.



Grounding

Make sure the product is properly grounded.

- If the product is not grounded, it can cause electric shock or electric leakage.
- For grounding work, consult an electric technician nearby.

**Warning**

 Wet hand prohibited

Do not touch the power cord with wet hands.

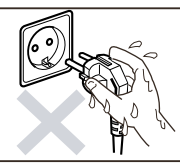

 Fire prohibited

Do not place fire such as cigarette near the product.

Do not step on, shock, or place heavy objects on the seat, cover, or main body.

Do not bend or crush the connecting hose.

Do not place hand or clothes on the warm air outlet.

Do not put into toilet anything else except toilet paper.



 Do not disassemble

When cleaning, use mild detergent and do not use the following  
(bathroom detergent, household detergent, benzene, paint thinner, nylon scrubber)

Do not remove the strainer while the shutoff valve is open.  
- It can splash water.



When installing the strainer, connect it tightly.  
- Otherwise, it can cause water leakage.

When the water leaks, close the shutoff valve to stop water supply.

 Observe strictly

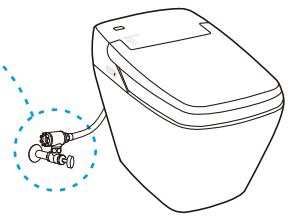
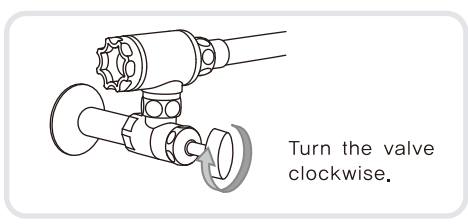

Make sure the temperature of the bathroom does not fall under 5°C.  
- When the water freezes, it can break water supply piping or internal parts, and cause water leakage & malfunction.

# Cautions in Use

Observe the followings.

Clean the seat and cover with wet soft cloth.

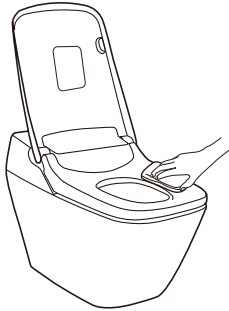

Do not expose the product to direct sunlight.

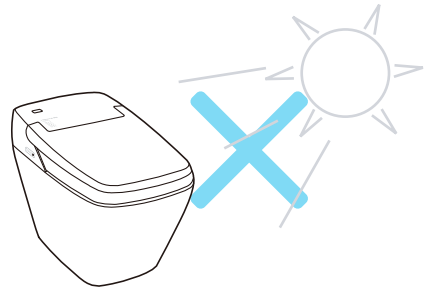

Make sure urine not to splash on the main body.

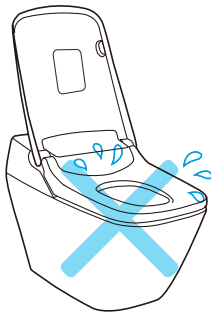

Do not cover the seat sensor, body detection sensor, and remote control transmitter and receiver.



Unplug the main power cable when not using the product for a long time.

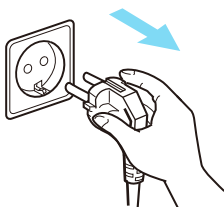

Turn off the main power (circuit breaker) when there is rainstorm with thunder.



When using radio, keep an appropriate distance from the product.

Do not lean back on the seat cover while seated.

# Proper Usage

- When using power saving.

The power saving mode will be released for 1 hour after the user uses the toilet. The temperature will be maintained at 30°C in automatic power saving mode.

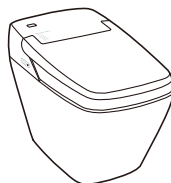

- Turn off the power when you not use the product for a long time.

Turn off the power to save power if it is not used for a long time.



- Use the flushing button pertinently.

For water saving, press the flushing button for each pertinent use.



# Functions

Division	Function	Descriptions
Basic	Posterior Wash	Cleanse posterior.
	Feminine Wash	Cleanse feminine area.
	Enema	Good for constipation patients to help pass motions.
	Dry	Dry the wet part after cleansing.
	Water Pressure	Adjust water pressure.
	Nozzle Position	Adjust nozzle position.
	Oscillating	Cleanse with nozzle movement back and forth.
	Pulsating	Stream water more rhythmically to clean more thoroughly.
	Rhythm	Enjoy Oscillating and Pulsating wash all together.
Convenient	Seat Temperature	Adjust seat temperature.
	Water Temperature	Adjust water temperature.
	Dry Temperature	Adjust dry temperature.
	Remote Control	All functions of bidet to be operated by remote control.
	Operation Lamp	Indicate current operation. (power, seat sensor, power saving, seat temp, water temp)
Water Saving	Full flushing	Perfect flushing available by 6.0ℓ
	Small flushing	Perfect flushing available by 4.0ℓ
Comfortable	Deodorant	Eliminates bad smell from the bathroom.
	Remote Control Flushing	Full flushing and small flushing available by remote control.
	Auto Flushing	Automatically flush the ceramic toilet by distinguishing feces and urine.
	Auto lid OPEN / CLOSE	TCB080SA - When you stand in front of the toilet, the lid automatically opens, and when you move away from the toilet, the lid automatically closes.
	LED light	TCB080SA - Automatically light sensors detect the motion and make the LED function on/off. TCB080SL - It can be operated by pressing the button of remote control.
Safe	Power Saving	Save power while no use.
	Antishort Circuit	Shut off power automatically at short circuit.
	Burn Protecting	Seat temperature goes off to protect from burn when sitting on the seat for over 30 minutes.
	Anti Bacterial	Specially coat nozzle, seat and lid against bacteria.
	Emergency Button	Emergency button to use when the remote control is out of order. (power, posterior, feminine, auto flush)
	Manual Flush Button	Manually flush under power failure.
	Self Checking	Automatically detect any malfunctions before use.
Refreshing	Nozzle Cleaning	Automatically clean nozzle before & after use.
	Nozzle Button	A button when to clean nozzle.
	Anti Pollutant Coating	Special coating on bowl.



# Names of Parts

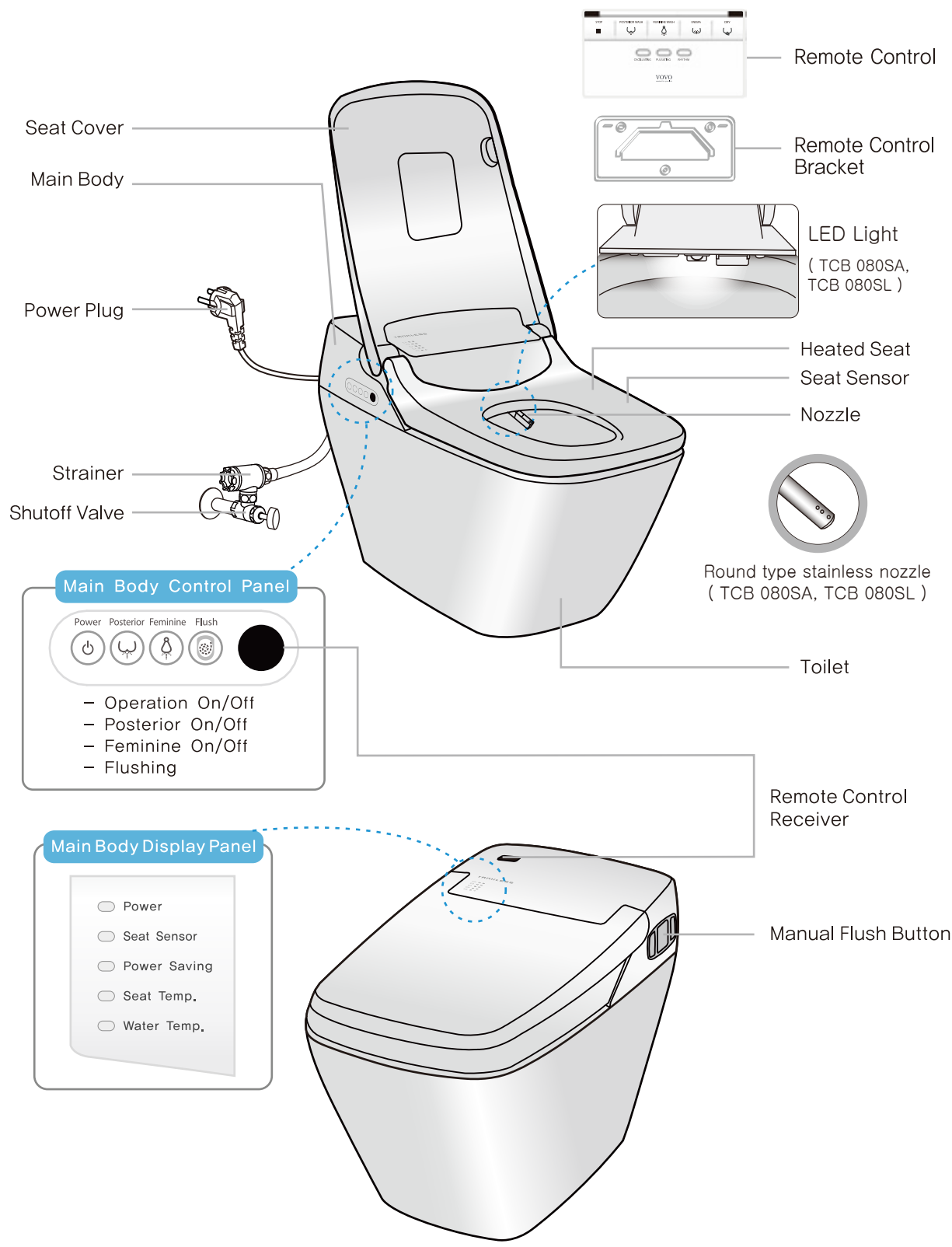

# Remote Control

< TOP >

Remote Control Transmitter

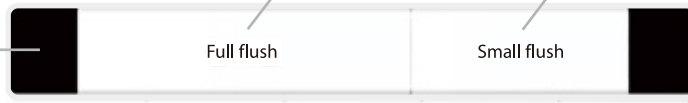

Flushing Button

< TCB 080SA >

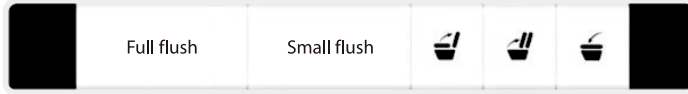

< COVER CLOSE >

Stop Button  
Posterior Wash Button  
Feminine Wash Button  
Oscillating ON/OFF

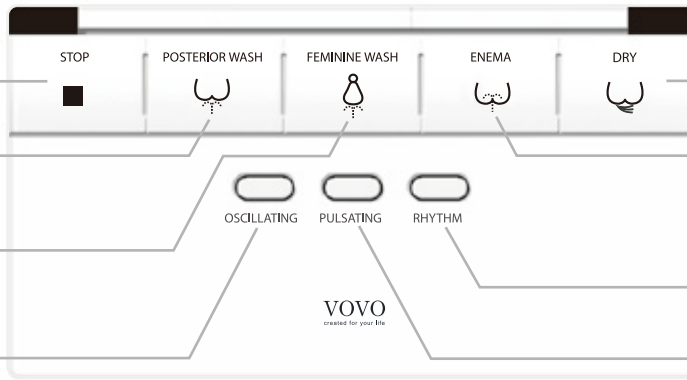

Dry Button

Enema Button

Rhythm ON/OFF

Pulsating ON/OFF

< COVER OPEN >

Water Pressure  
Seat Temperature  
Water Temperature  
Dry Temperature

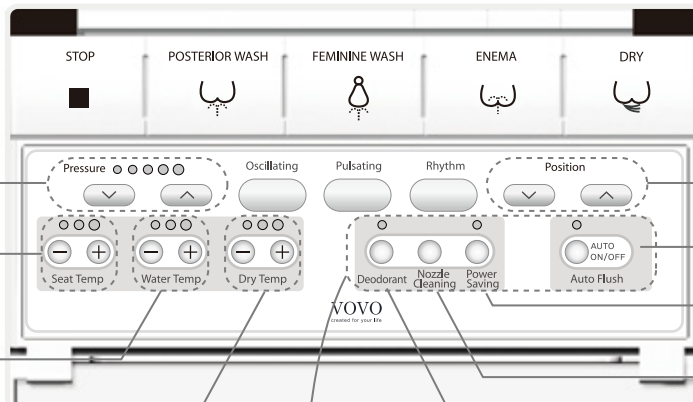

Nozzle Position

Auto Flushing ON/OFF

Power Saving ON/OFF

Nozzle Cleaning

Deodorant ON/OFF

< TCB 080SA >

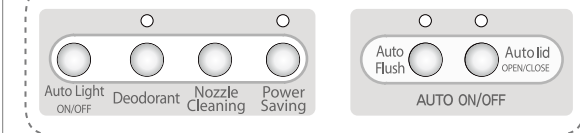

< TCB 080SL >

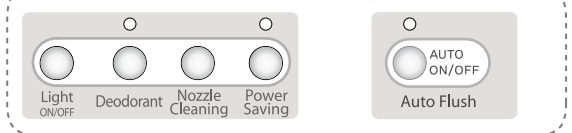

# Preparation and Check Before Use

## Preparation

### 1 Place the battery into the remote control

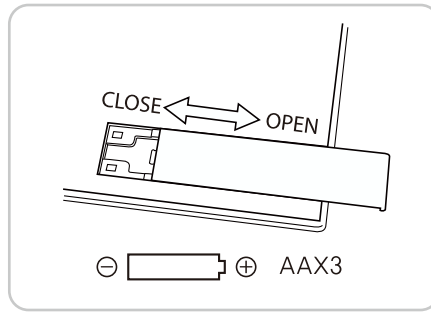
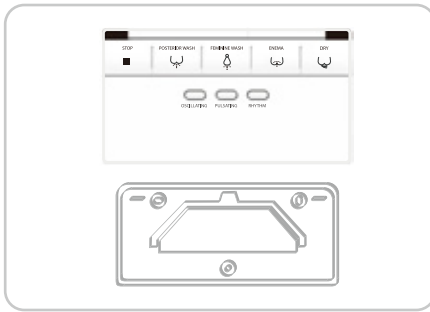

#### Advice 1

- ① Hold it on both sides and lift up.
- ② Open the batter cover on the back.
- ③ Put 3 AA batteries in order.
- ④ Close the cover.

#### About the battery

- Observe the following to prevent breakage or leakage of fluid.

- Use the same type of batteries when to replace old batteries
- Remove batteries when not used for a long time.
- Do not use rechargeable batteries

Sometimes the settings (temperature, auto flush) are initialized after replacing batteries. Configure the settings again.

### 2 Check if the power plug is connected

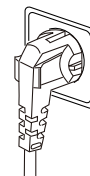

- Advice 1** Turn off the power  on the main body when replacing batteries or cleaning the product.

### 3 Adjust water flow with the shutoff valve

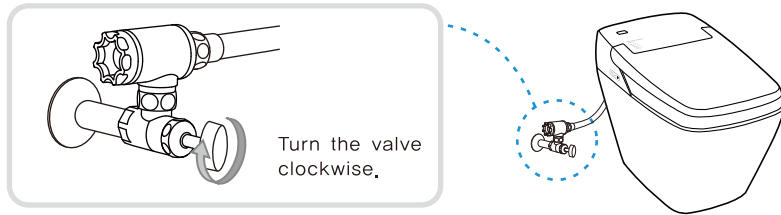

If the pressure is high, the water may splash or overflow when cleaning the ceramic bowl. To reduce the water pressure.

## Check

### 4 Check the display panel

● Is the operation lamp on?

● Is the seat lamp on?

If not on, press the Power button  to turn on the lamp.

If not on, open the remote control cover and press Seat Temperature to turn it on.

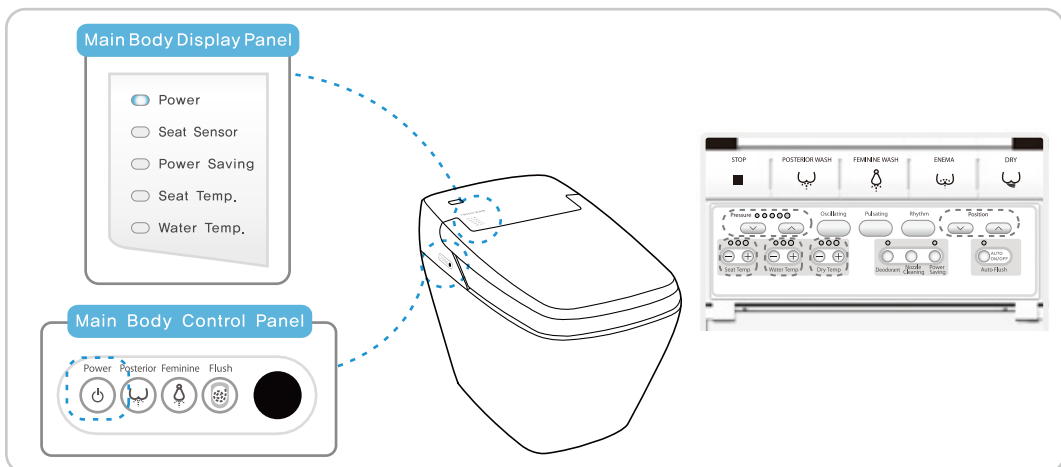

# How to Use

## 1 Sit on the seat

- The seat lamp will turn on.
- It operates after being occupied (Refer to page 9, seat sensor)

## 2 Press the flush button on the remote control

- (Only when using the product for the first time after installation)
- Water will fill the toilet to an appropriate level.

## 3



Press Posterior wash or Enema.

Press Feminine wash. **Advice 1**

- It works for one minute at each function.

How to use wash properly.

- Press wash, set the water spray to the center of anus.
- Control water pressure.
- If you feel that the water has filled you up a bit, push the water and motions out by forcing the abdomen.
- Pass motions and the water in a rectum completely.

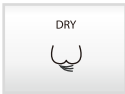

**Press Dry** - It works for 3 minutes.

## 4



**Press Stop**

- Stops Posterior wash, Feminine wash and Enema.

## 5



**Press Flush**

## How to use it more comfortably

### Comfortable 1 Oscillating

Nozzle moves back and forth to cleanse.

1. Press the button to wash.
2. Press Oscillating.  
- Nozzle moves while washing.
3. Press again.  
- Stop Oscillating.

### Comfortable 2 Pulsating

Stream water more rhythmically.

1. Press the button to wash.
2. Press Pulsating.  
- Spray Pulsating while washing
3. Press again.  
- Stop Pulsating.

### Comfortable 3 Rhythm

Enjoy Oscillating and Pulsating all together.

1. Press the button to wash.
2. Press Rhythm.  
- Spray water rhythmically.
3. Press again.  
- Stop Rhythm.

**Advice 1** Do not sit on the edge, but toward the inside of seat. This way lessens water splash in a proper position.

## Adjusting Temperature

- The temperature of the seat and drying air can be adjusted with the remote control. Choose the appropriate temperature.

### 1 Open the remote control cover.

### 2 Adjust the temperature.

- Use **-** **+** button to adjust the temperature of seat, water and drying air to up to 3 levels.

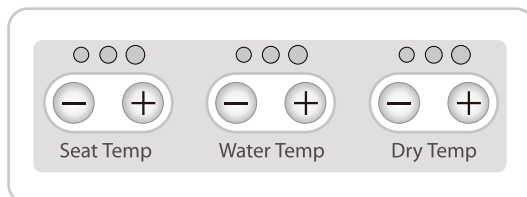

#### Seat Temperature



#### Water Temperature



#### Dry Temperature

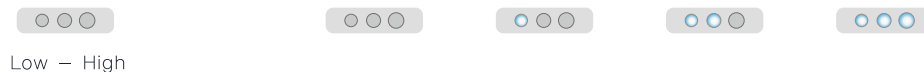

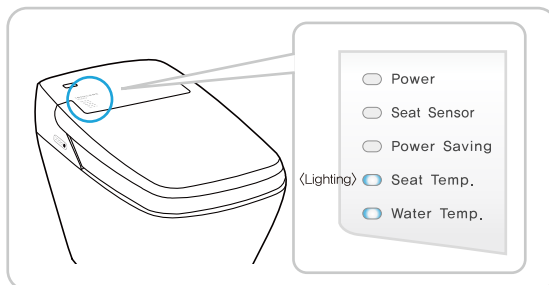

- When you turn on the seat temperature, the Seat lamp will be turned on in the display area of main body.
- When you turn on the water temperature, the Water lamp will be turned on in the display area of main body.



## Adjusting and Using Functions



- The water pressure and nozzle position can be adjusted with the remote control.

### Adjust water pressure

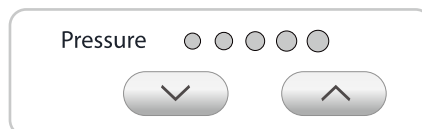

- The water pressure can be adjusted up to 5 different levels with  and  buttons. Adjust the water pressure to your preference.



### Adjust nozzle position



- While Posterior or Feminine wash, press  or  button to adjust the nozzle position to your body.
- The nozzle will move from the middle each time you use.

### Clean Nozzle

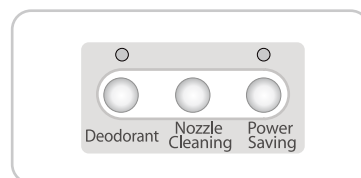

- Press the  button for 3 seconds to extend the nozzle without sitting on the seat.
- Using a toothbrush, clean the nozzle and press the  button again then the nozzle will automatically revert to the original position, and clean itself.



### Deodorant

- Press the  button to turn the lamp on.
- It deodorizes automatically when sitting.  
(It works for max 20 minutes after being occupied, and works for another 1 minute before stop after standing up.)
- Press the  button again to cancel it.

### Power Saving

- Press the  button to turn on the power saving lamp on the main body.
- In power saving mode, the water temperature and seat temperature will be maintained at 30°C.
- To cancel the power saving mode, press the  button again to turn off the display lamp.
- When you use the product in the power saving mode, the mode will be cancelled automatically and it will revert to power saving mode when you stand up.

- In the power saving mode, the temperature of water or seat can be lower than the setting.

# Flushing

There are 2 ways to flush the toilet; Remote Control Toilet Flush and Auto Flush

## Remote Control Toilet Flush



Full flush

Small flush

Press remote control

## Auto Flush

Press the  button to turn the lamp on.

Water flushes down automatically by sensor after standing up.

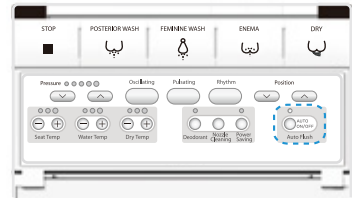

## Clean the toilet when power is out

- Open the main body cover for toilet flushing.
- 1. Press the Bowl cleaning button for 3 seconds.
- 2. Press the Flush button for 5 seconds.
- 3. Press the Bowl cleaning button again for 3 seconds.

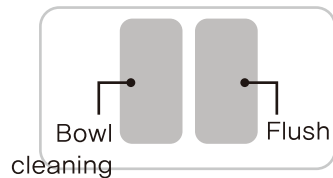

- ※ Bowl cleaning functions to clean the inner ceramic bowl.
- ※ Flush functions to jet high pressure water to flush down the soil in the bowl.

## When the batteries are running down

- Press the Flush button  on the control panel of main body.

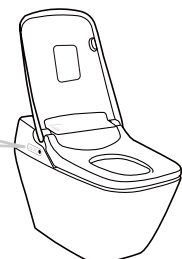
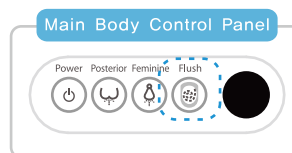



## Open and Close the Toilet Seat and Lid – TCB 080SA

There are 2 settings for opening and closing toilet seat and lid.  
The remote controlled setting and the automatic setting.

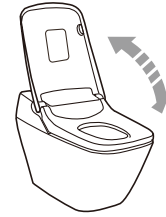

### Remote Controlled Open/Close of Toilet Seat and Lid

- The toilet seat and lid can be opened and closed by pressing the specific button on the remote controller.

- **Press the specific button on the remote controller.**



The toilet seat and lid open and close

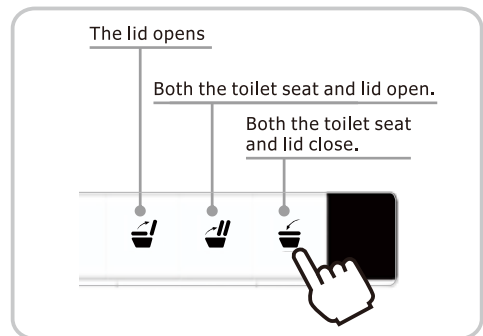

### Automatic Open/Close of Toilet Seat and Lid

- When you stand in front of the toilet, the lid automatically opens, and when you move away from the toilet, the lid automatically closes.

\* **Check** Check 'Auto lid open/close'

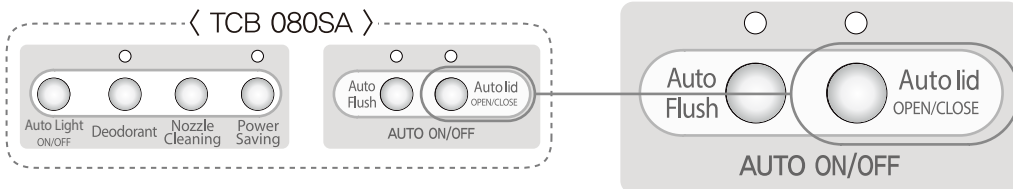

Auto Seat and Lid open/close button.

# Maintenance

Give attention to the following procedures.

Turn off the Auto Flush.



## Ordinary maintenance

### ◆ Main Body, Seat and Lid.

- Wet soft cloth**
  - Clean with wet cloth. **Advice 1·2**
- Remove toilet detergent**
  - Wipe it with wet soft cloth.
- If the product is seriously contaminated**
  - Wipe it with soft cloth and mild detergent.
  - Remove the moisture completely.
- Clean bathroom floor**
  - If there are spots of urine around the toilet, wipe it with wet towel.

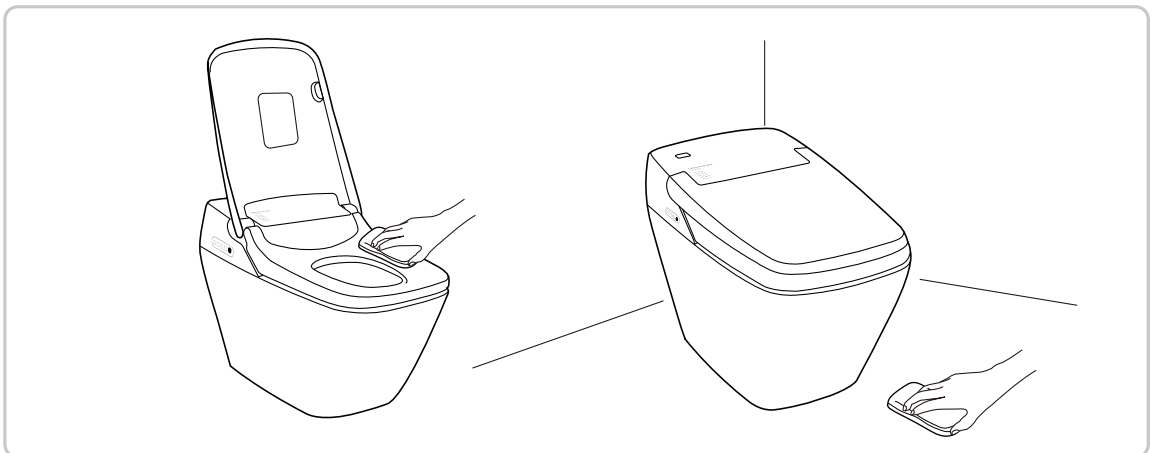

**Advice 1** Tankless® is an electric appliance.  
Make sure water does not get into the product.

**Advice 2** Keep the seat sensor, remote control transmitter and receiver clean.  
If sensors are not clean, the product may malfunction or can not function at all.

## Handle Deodorization filter (Once a month is appropriate)

- When cleaning the deodorization filter, take the following steps.

### 1 Remove the deodorization filter

- Pull the filter forward.

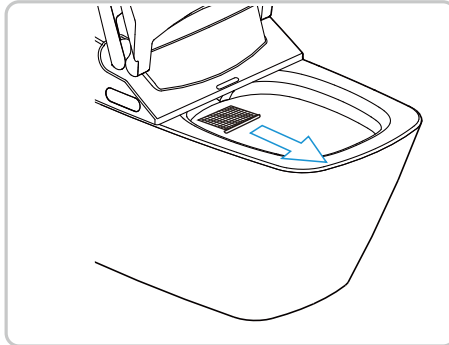

### 2 Clean

- Using a toothbrush, remove the dust particles off the filter.

Advice 1

### 3 Place the filter

- Push back until it clicks.

※ Do not use without the filter. It can cause trouble.

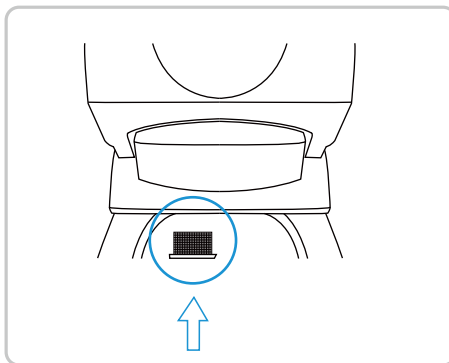

#### Advice 1 Clean Filter

- You can wash the filter with water but please dry it with cloth before putting it back to the main body.

## Other Maintenance

### ◆ Clean Strainer

- If you feel the water pressure is weak, clean the strainer.

#### 1 Close the shutoff valve

- Close turn the valve to the clockwise.

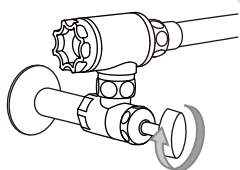

#### ⚠ Attention



Prohibited

- Do not separate the strainer while the valve is open.
- The water will pour out.

#### 2 Open the strainer

- Open turn the strainer to the anticlockwise.

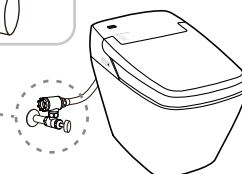
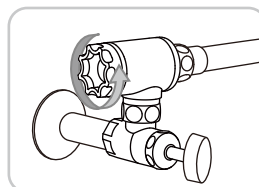

#### 3 Clean the strainer

- Clean the strainer with water thoroughly to remove the dregs.
- ※ Use a toothbrush to remove small particles thoroughly.
- ※ Use scrubber to remove the dust particles or dregs inside the shutoff valve.

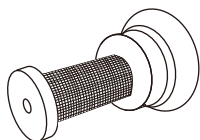

Advice 1

#### 4 Replace the strainer

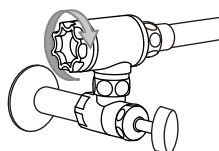

- Turn the strainer to the clockwise.

#### ⚠ Attention



Observe strictly

- Make sure to screw up tightly.
- If not, it may leak.

#### 5 Open the shutoff valve

- Open turn the valve to the anticlockwise.
- ※ Check whether the water leaks from the shutoff valve.

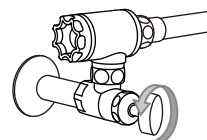

Advice 1

- Clean the strainer
- Do not use detergent, but use water only.
- Do not apply excessive force to the strainer. It may deform the part.

## Clean Nozzle

- Only the nozzle will extend out without spraying water.

### 1 Extend the nozzle

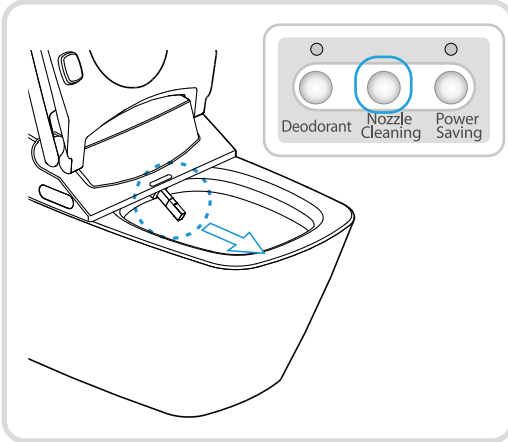



- Press Nozzle cleaning  button on the remote control.
- The nozzle will move back in 5 minutes automatically.

### 2 Clean the nozzle

- Use soft or toothbrush to clean the nozzle.
- ※ Do not pull out or push the nozzle forcibly.  
(It may cause breakage or trouble.)

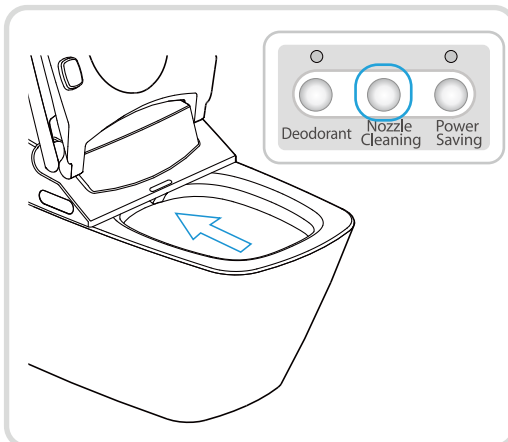
### 3 Return the nozzle



- Press Nozzle cleaning  button again.

The nozzle will move back and clean itself.

- ※ Do not push the nozzle by hand.  
It may cause breakage or trouble.

# Troubleshooting

If you think the product is out of order, please refer to the following first.  
If the problem is still not solved, then contact local dealer or service center.

## Attention

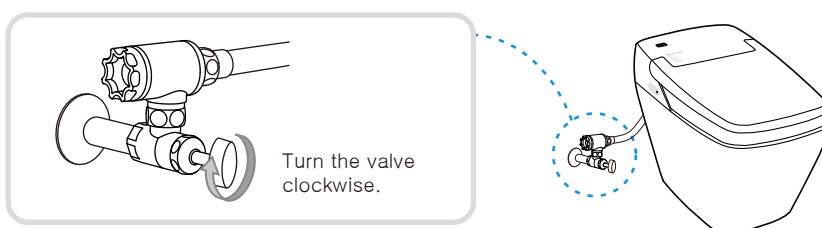

- ※ Please unplug the power cord when requesting for repair service.
- ※ If the supply cord is damaged, it must be replaced by the manufacturer, its service agent or similarly qualified persons in order to avoid a hazard.
  - This appliance is not intended for use by persons (including children) with reduced physical, sensory or mental capabilities, or lack of experience and knowledge, unless they have been given supervision or instruction concerning use of the appliance by a person responsible for their safety.
  - Children should be supervised to ensure that they do not play with the appliance.
  - The new hose-sets supplied with the appliance are to be that used and that old hose-set should not be reused.
- ※ When the water leaks, close the shutoff valve first to stop water supply.

 Observe strictly















- Check the following before requesting for repair service.

## Power supply

Trouble	Possible Causes	Solution
The unit is not working.	Isn't the power out or isn't the circuit breaker off?	Wait until the power is restored. Or turn on the circuit breaker.
	Isn't the operation lamp on the display panel of the main body off?	Turn on the power  in the control panel of the main body.  Refer to page 12

## Posterior wash, Feminine wash, Enema, Kid funtion

Trouble	Possible Causes	Solution
Water is not spraying out.	Isn't the water supply suspended?	Wait until the water supply is resumed.
	Isn't the shutoff valve closed?	Open the valve.  Refer to page 12
	Isn't human body out of the location of seat sensor?	Refer to the Seat Sensor part.
	Isn't the hose twisted?	Loosen the hose.
Water pressure is weak.	Isn't the water pressure set to low level?	Press  button on the remote control.  Refer to page 15
	Isn't the strainer clogged?	Clean the strainer.  Refer to page 18
Water is cold.	Isn't the temperature set to a low level? Or is it turned off?	Adjust with   buttons on the remote control.  Refer to page 14
	Isn't it in power saving mode?	The water temperature is set lower, the temperature goes up after sitting.
Water stops in the middle of cleasing.	Press one of    buttons, then it will stop automatically in 5 minutes.	Press the    button again.
	Isn't human body out of the location of seat sensor?	Refer to the location of Seat Sensor on page 9.

Trouble	Possible Causes	Solution
The water flows in to toilet for a few seconds near the nozzle when I sitting on the toilet.	When the seat sensor is on, it releases some water before spraying. Or if you change position while seated, the sensor will turn on and off and release some water, but it is not a trouble.	-



## Seat Sensor

Trouble	Possible Causes	Solution
The posterior wash or deodorant function works without sitting on the seat.	Isn't the seat sensor blocked with wet towel?	Remove the wet towel.
	Is the seat sensor wet?	Wipe out the water with dry cloth.

## Auto Flushing

Trouble	Possible Causes	Solution
Auto flushing is not working.	Isn't the auto flushing turned off? (When off, the flushing indication on the remote control display panel is off)	Press auto flushing  button on the remote control again to turn it on

## Heated Seat

Trouble	Possible Causes	Solution
The seat is not warm.	Isn't the seat temperature set to low level?	Adjust seat temperature with  buttons on the remote control.  Refer to page 14
	Isn't it in power saving mode?	Sit on the seat and wait for about 5 minutes.
The seat is cold.	The heater turns off automatically 1 hour after you sit on the seat. When you stand up, the heater will turn on again.	-





## Remote Control

Trouble	Possible Causes	Solution
Remote control is not working.	Aren't the batteries running down?	Replace old batteries with new ones.  Refer to page 11
	Aren't the polarities of batteries misplaced?	Insert batteries in order.
	Aren't the transmitter, receiver of the remote control blocked?	Remove the objects blocking transmitters.
	Aren't the transmitter, receiver of the remote control contaminated?	Wipe out the dust or water stain.
	Isn't human body out of the location of seat sensor?	Refer to the location of seat sensor on page 9.





## Flushing by Remote Control

Trouble	Possible Causes	Solution
I can't flush the toilet with remote control.	Aren't the batteries running down?	Replace old batteries with new ones.
	Didn't you press the button consecutively?	This function cannot be used consecutively. You will need to wait for about 10 seconds for next flush.
	Aren't the transmitter areas of remote control contaminated?	Clean the dust or water stain.



## Deodorization

Trouble	Possible Causes	Solution
Deodorization is not working at all.	Isn't human body out of the location of seat sensor?	Refer to the location of Seat Sensor on page 9.
Deodorization is not very effective.	Isn't the deodorization filter clogged?	Clean the deodorization filter.  Refer to page 18
Deodorization is not working at all.	Is the lamp on the main body on?	Set the deodorant function.  Refer to page 15



## Drying

Trouble	Possible Causes	Solution
Drying air temperature is low.	Isn't the air temperature set to a low level?	Adjust the air temperature with   buttons on the remote control.  Refer to page 14
The air blow stops in progress.	Press  then it will stop automatically after 3 minutes.	Press  again.
	It may stop if user changes his position while sitting.	Refer to the location of Seat Sensor on page 9.
The warm air drying function is not working at all.	Isn't human body out of the location of seat sensor?	Refer to the location of Seat Sensor on page 9.

## Power Saving

Trouble	Possible Causes	Solution
Power saving is not working.	Isn't it unplugged? Didn't you change batteries?	It may not work normally on the day you made setting but it will work normally from the next day.
	Didn't you change batteries when you unplugged the power or when the power was out? (The time setting can be reset)	Press the  button or  button again to turn it on.  Refer to page 15

## Others

Trouble	Possible Causes	Solution
The soil is not completely flushed down.	Is the shutoff valve open enough?	Open the shutoff valve sufficiently.  Refer to page 14
	Isn't the strainer in the shutoff valve clogged?	Clean the strainer.  Refer to page 14
	Aren't you using water in other places than the bathroom?	-
The flushing water is not supplied.	Isn't the shutoff valve closed?	Open the shutoff valve sufficiently.  Refer to page 14
	Isn't the water supply suspended?	Wait until the water supply is resumed.
Water is leaking from the pipe joint.	Isn't the screw on the joint loosened?	Tighten the screw with a screwdriver.

# Customer Support

Before requesting for repair service, please check <Troubleshooting>

## ● Limited Warranty

- This manual includes the Warranty. Please complete the appropriate information (distributor, installation date) and read the Warranty carefully.
- The warranty period is 1 year from purchase date.

## ● Minimum storage period of replacement parts for repair use

- The minimum storage period of replacement parts for repair is 6 years from the completion of manufacture.

## ● In case of requesting for repair under warranty

- Please read the manual carefully again, and if there are still troubles, contact your local dealer or service center.
- Please submit the warranty card when requesting for repair service.

### Information needed when requesting for repair

- |                                     |                     |
|-------------------------------------|---------------------|
| - Address, name, telephone No.      | - Product name      |
| - Desired date for repairer's visit | - Serial Number     |
|                                     | - Installation Date |

## ● In case of requesting for repair after warranty

- Please contact local dealer or service center.  
In case the product's function can be maintained by repair, we will provide pay repair service upon request.

## Recommendation of Regular Inspection (pay)

- We recommend regular inspection approximately 3 years after the installation to maintain the product in good order. Please contact local dealer.

### Detail of repair charge (When requesting for customer service)

The repair cost means [Technical Support Fee] + [Part Cost] + [Travelling Expenses]

[Technical Support Fee] is required for diagnosis, repair, replacement or adjustment of parts.

[Part Cost] is the cost of the parts used for repair.

[Travelling Expenses] is required when dispatching certified technician to the location of the product.

# Specifications

Model No.		TCB-080	TCB - 080SL	TCB - 080SA
Rated Voltage		230V~, 50 / 60Hz		
Rated Power Consumption		710W		
Power Cord Length		1.5m (5feet)		
Toilet	Water Consumption	Full flush: 6ℓ / Small flush: 4ℓ		
	Flushing System	Siphon jet, Tornado flushing		
Wash Unit	Posterior Wash	Max 1.2ℓ/min [when water pressure is 2.0kgf/cm <sup>2</sup> (0.2Mpa)]		
	Feminine Wash	Max 1.2ℓ/min [when water pressure is 2.0kgf/cm <sup>2</sup> (0.2Mpa)]		
	Enema	Max 1.2ℓ/min [when water pressure is 2.0kgf/cm <sup>2</sup> (0.2Mpa)]		
	Water Temperature	Adjustable, 34°C ~ 40°C		
	Water Tank	1.2L		
	Heater Capacity	600W		
Safety Device		Thermal cutoff, Overheating prevention circuit, Temperature sensor		
Heated Seat	Seat Temperature	Adjustable, 34°C ~ 40°C		
	Heater Capacity	55W		
	Safety Device	Thermal cutoff, Temperature sensor		
Dry	Hot Air Temperature	Adjustable, 40°C ~ 59°C		
	Heater Capacity	250W		
	Safety Device	Thermal cutoff, Temperature overheat preventer (manual recovery bimetal)		
Deodorization		Automatic deodorizer		
Lighting		—	LED light	Auto LED light
Auto lid		—		Auto lid
Water Pressure		Min : 1.5kgf/cm <sup>2</sup> (0.15Mpa) [with 20ℓ/min flow] Max : 7.5kgf/cm <sup>2</sup> (0.75Mpa)		
Waterproof rating		IPX4		
Inlet water Temperature		5°C ~ 35°C		
Ambient Temperature		5°C ~ 40°C		
Dimension		W 410mm x L 720mm x H 525mm		
Weight		27kg [Bidet 8kg, Toilet 19kg]		

## WEEE Directive



This marking shown on the product or its literature, indicates that it should not be disposed with other household wastes at the end of its working life. To prevent possible harm to the environment or human health from uncontrolled waste disposal, please separate this from other types of wastes and recycle it responsibly to promote the sustainable reuse of material resources.

Household users should contact either the retailer where they purchased this product, or their local government office, for details of where and how they can take this item for environmentally safe recycling.

Business users should contact their supplier and check the and conditions of the purchase contract. This product should not be mixed with other commercial wastes for disposal.

## Limited Warranty

The product is warranted for one year according to the description written in this warranty.

Please submit this warranty card to local dealer or service center.

Model :		Serial Number :	
Purchaser			
Company :			
Address :			
City :		Country :	
Phone :		Fax :	E-mail :
Dealer(Company)			
Address :			
Installation Date :		Warranty period	
		1 years from purchase date	

Complete the above warranty card when purchasing the product. Check the information and keep it safe.

### Pay Repair Regulations

1. Defects and/or malfunctions from failure to properly install, operate and/or maintain the unit in accordance with the installation manual.
2. Damage from abuse, fire, flood, freeze, and any other acts of nature.
3. Damage resulting from unauthorized alterations, attachments and/or repairs.
4. If the product was not installed properly for residential use.
5. Damage from installing the unit in an environment with animals, mice or insects.
6. Damage caused by excess moisture or from water clogging the water closet.
7. Damage from not being installed in accordance with all applicable local codes, ordinances and good trade practices.
8. Color fading due to use in wrong environments.
9. Damage from consumable chemicals.
10. The warranty will not be covered without providing the date of purchase with original receipt.
11. Damage from misuse due to not following the installation manual.

MEMO

MEMO



---

**Head office / Korea**

9F, 449-3, Gangnam-daero, Seocho-gu, Seoul, Republic of Korea (06611)  
Tel. +82-2-523-0631, 0632 / Fax. +82-2-523-0630

---

**R&D / Factory**

6173-21, Seodong-daero, Samjuk-myeon, Anseong-si, Gyeonggi-do, Republic of Korea  
Tel. +82-31-672-0634, 0635 / Fax. +82-31-672-0630